

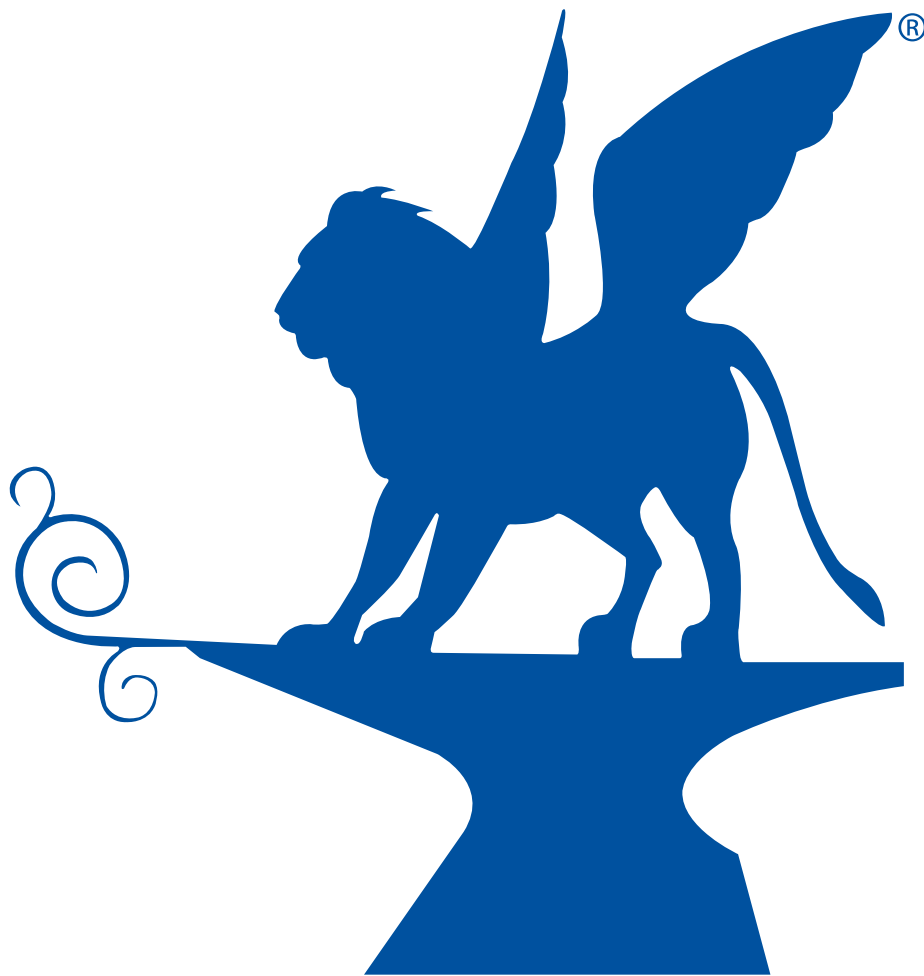

ARTEFERRO
Compendium

Ferro Battuto, Wrought Iron, Hierro Forjado, Schmiedeeisen,
Fer Forge, Ferro Forjado, Smidesjarn, Ковка, Kovano Zeljezo, Fer Forjat

BARRE FORATE - PIERCED BARS



ind.i.a.® S.
P.
A.
industria italiana arteferro

BARRE FORATE A CALDO - HOT PIERCED BARS



L 2000 mm



Sezione Section	Cod.art. Art.no.	Interasse Pitch	Foro Hole	Luce Distance	Numero Fori Holes Number
Ø 12 mm	1360/6	120 mm	Ø 12 mm	108 mm	16
Ø 14 mm	42/1	140 mm	Ø 14 mm	126 mm	14
	42/A/1	124 mm	Ø 14 mm	110 mm	14
Ø 16 mm	42/2	150 mm	Ø 16 mm	134 mm	13
	42/A/2	126 mm	Ø 16 mm	110 mm	14
Ø 18 mm	42/3	160 mm	Ø 18 mm	142 mm	12
	42/A/3	128 mm	Ø 18 mm	110 mm	14
Ø 20 mm	42/4	170 mm	Ø 20 mm	150 mm	11
	42/A/4	130 mm	Ø 20 mm	110 mm	14
Ø 22 mm	42/5	170 mm	Ø 22 mm	148 mm	11
Ø 25 mm	42/6	180 mm	Ø 25 mm	155 mm	10
Ø 30 mm	42/7	200 mm	Ø 30 mm	170 mm	9



L 2000 mm



Sezione Section	Cod.art. Art.no.	Interasse Pitch	Foro Hole	Luce Distance	Numero Fori Holes Number
Ø 14 mm	606/1	140 mm	Ø 14 mm	126 mm	14
Ø 16 mm	606/2	150 mm	Ø 16 mm	134 mm	13
Ø 18 mm	606/3	160 mm	Ø 18 mm	142 mm	12
Ø 20 mm	606/4	170 mm	Ø 20 mm	150 mm	11

Cod.art. Art.no.	Da abbinare con To couple with
606/1	598/14
606/2	598/15
606/3	598/16
606/4	598/17

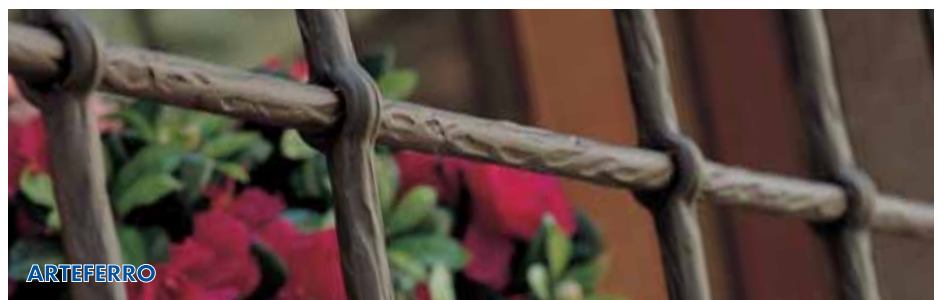

L 2000 mm



Sezione Section	Cod.art. Art.no.	Interasse Pitch	Foro Hole	Luce Distance	Numero Fori Holes Number
Ø 14 mm	607/1	140 mm	Ø 28 x 14 mm	126 mm	14
Ø 16 mm	607/2	150 mm	Ø 32 x 16 mm	134 mm	13
Ø 18 mm	607/3	160 mm	Ø 34 x 18 mm	142 mm	12
Ø 20 mm	607/4	170 mm	Ø 38 x 20 mm	150 mm	11

BARRE FORATE A CALDO - HOT PIERCED BARS

L 2000 mm



Sezione Section	Cod.art. Art.no.	Interasse Pitch	Foro Hole	Luce Distance	Numero Fori Holes Number
Φ 12 x 12 mm	1360/7	120 mm	Φ 12 x 12 mm	108 mm	16
Φ 14 x 14 mm	42/8	140 mm	Φ 14 x 14 mm	126 mm	14
	42/A/5	124 mm	Φ 14 x 14 mm	110 mm	14
Φ 16 x 16 mm	42/9	150 mm	Φ 16 x 16 mm	134 mm	13
	42/A/6	126 mm	Φ 16 x 16 mm	110 mm	14
Φ 18 x 18 mm	42/10	160 mm	Φ 18 x 18 mm	142 mm	12
	42/A/7	128 mm	Φ 18 x 18 mm	110 mm	14
	42/A/17	122 mm	Φ 12 x 12 mm	110 mm	14
	42/A/18	124 mm	Φ 14 x 14 mm	110 mm	14
Φ 20 x 20 mm	42/11	170 mm	Φ 20 x 20 mm	150 mm	11
	42/A/8	130 mm	Φ 20 x 20 mm	110 mm	14
Φ 22 x 22 mm	42/12	170 mm	Φ 22 x 22 mm	148 mm	11
Φ 25 x 25 mm	42/13	180 mm	Φ 25 x 25 mm	165 mm	10
Φ 30 x 30 mm	42/14	220 mm	Φ 30 x 30 mm	190 mm	9

L 2000 mm

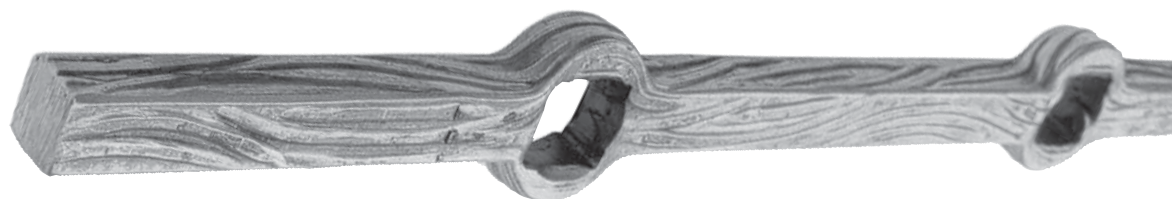

Sezione Section	Cod.art. Art.no.	Interasse Pitch	Foro Hole	Luce Distance	Numero Fori Holes Number
Φ 14 x 14 mm	605/1	140 mm	Φ 14 x 14 mm	126 mm	14
Φ 16 x 16 mm	605/2	150 mm	Φ 16 x 16 mm	134 mm	13
Φ 18 x 18 mm	605/3	160 mm	Φ 18 x 18 mm	142 mm	12
Φ 20 x 20 mm	605/4	170 mm	Φ 20 x 20 mm	150 mm	11



Cod.art. Art.no.	Da abbinare con To couple with
605/1	623/6
605/2	623/7
605/3	623/8
605/4	623/9

L 2000 mm



Sezione Section	Cod.art. Art.no.	Interasse Pitch	Foro Hole	Luce Distance	Numero Fori Holes Number
Φ 14 x 14 mm	1845/20	140 mm	∇ 24 x 15 mm		11
Φ 16 x 16 mm	1845/21	150 mm	∇ 30 x 17 mm		10
Φ 18 x 18 mm	1845/22	160 mm	∇ 31 x 19 mm		10
Φ 20 x 20 mm	1845/23	170 mm	∇ 33 x 21 mm		9

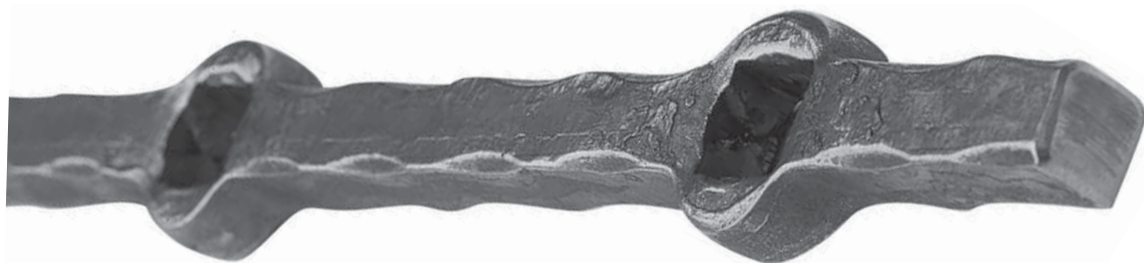

L 2000 mm

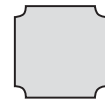

Sezione Section	Cod.art. Art.no.	Interasse Pitch	Foro Hole	Luce Distance	Numero Fori Holes Number
Φ 12 x 12 mm	I360/1	120 mm	Φ 12 x 12 mm	108 mm	16
Φ 14 x 14 mm	I360/2	140 mm	Φ 14 x 14 mm	126 mm	14
Φ 16 x 16 mm	I360/3	150 mm	Φ 16 x 16 mm	134 mm	13
Φ 18 x 18 mm	I360/4	160 mm	Φ 18 x 18 mm	142 mm	12
Φ 20 x 20 mm	I360/5	170 mm	Φ 20 x 20 mm	150 mm	11

Cod.art. Art.no.	Da abbinare con To couple with
I360/1	118/1
I360/2	118/2
I360/3	118/4
I360/4	118/5
I360/5	118/6



ARTEFERRO



L 2000 mm

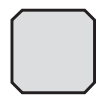

Sezione Section	Cod.art. Art.no.	Interasse Pitch	Foro Hole	Luce Distance	Numero Fori Holes Number
Φ 12 x 12 mm	GD124/9	120 mm	Φ 12 x 12 mm	108 mm	16
Φ 14 x 14 mm	GD124/10	140 mm	Φ 14 x 14 mm	126 mm	14
Φ 16 x 16 mm	GD124/11	150 mm	Φ 16 x 16 mm	134 mm	13
Φ 18 x 18 mm	GD124/12	160 mm	Φ 18 x 18 mm	142 mm	12
Φ 20 x 20 mm	GD124/13	170 mm	Φ 20 x 20 mm	150 mm	11
Φ 22 x 22 mm	GD124/14	170 mm	Φ 22 x 22 mm	148 mm	11
Φ 25 x 25 mm	GD124/15	180 mm	Φ 25 x 25 mm	155 mm	10
Φ 30 x 30 mm	GD124/16	200 mm	Φ 30 x 30 mm	170 mm	9

Cod.art. Art.no.	Da abbinare con To couple with	Da abbinare con To couple with	Da abbinare con To couple with
	L 2000 mm	L 3000 mm	L 6000 mm
GD124/9	118/A/44	GD124/17	GD124/25
GD124/10	118/A/17	GD124/18	GD124/26
GD124/11	118/A/18	GD124/19	GD124/27
GD124/12	118/A/19	GD124/20	GD124/28
GD124/13	118/A/20	GD124/21	GD124/29
GD124/14	118/A/21	GD124/22	GD124/30
GD124/15	118/A/22	GD124/23	GD124/31
GD124/16	118/A/23	GD124/24	GD124/32



ARTEFERRO

L 2000 mm

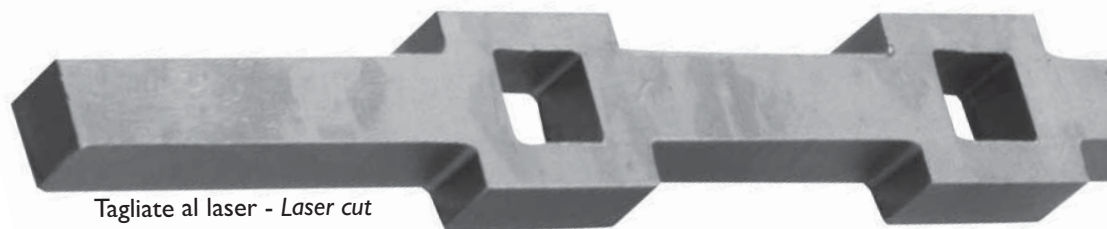

Tagliate al laser - Laser cut

Sezione Section	Cod.art. Art.no.	Interasse Pitch	Foro Hole	Luce Distance	Numero Fori Holes Number
Φ 14 x 14 mm	1845/6	125 mm	Φ 15 x 15 mm	110 mm	15
Φ 14 x 14 mm	1845/7	145 mm	Φ 15 x 15 mm	130 mm	12
Φ 16 x 16 mm	1845/8	127 mm	Φ 17 x 17 mm	110 mm	15
Φ 16 x 16 mm	1845/9	147 mm	Φ 17 x 17 mm	130 mm	12
Φ 25 x 25 mm	1845/10	136 mm	Φ 26 x 26 mm	110 mm	14



ARTEFERRO

L 2000 mm



Sezione Section	Cod.art. Art.no.	Interasse Pitch	Foro Hole	Luce Distance	Numero Fori Holes Number
Φ 12 x 12 mm	1361/5	140 mm	Φ 12 x 12 mm		14
Φ 14 x 14 mm	1361/6	150 mm	Φ 14 x 14 mm		13
Φ 15 x 15 mm	1361/7	160 mm	Φ 15 x 15 mm		12
Φ 17 x 17 mm	1361/8	170 mm	Φ 17 x 17 mm		11



Sezione Section	Da abbinare con To couple with
Φ 12 x 12 mm	626/10
Φ 14 x 14 mm	626/11
Φ 15 x 15 mm	626/12
Φ 17 x 17 mm	626/13

L 2000 mm



Sezione Section	Cod.art. Art.no.	Interasse Pitch	Foro Hole	Luce Distance	Numero Fori Holes Number
Φ 12 x 12 mm	1361/1	140 mm	Φ 12 x 12 mm		14
Φ 14 x 14 mm	1361/2	150 mm	Φ 14 x 14 mm		13
Φ 15 x 15 mm	1361/3	160 mm	Φ 15 x 15 mm		12
Φ 17 x 17 mm	1361/4	170 mm	Φ 17 x 17 mm		11



L 2000 mm



Sezione Section	Cod.art. Art.no.	Interasse Pitch	Foro Hole	Luce Distance	Numero Fori Holes Number
Φ 14 x 14 mm	42/22	140 mm	Φ 14 x 14 mm		14
	42/A/13	124 mm	Φ 14 x 14 mm		14
Φ 16 x 16 mm	42/23	150 mm	Φ 16 x 16 mm		13
	42/A/14	126 mm	Φ 16 x 16 mm		14
Φ 18 x 18 mm	42/24	160 mm	Φ 18 x 18 mm		12
	42/A/15	128 mm	Φ 18 x 18 mm		14
Φ 20 x 20 mm	42/25	170 mm	Φ 20 x 20 mm		11
	42/A/16	130 mm	Φ 20 x 20 mm		14
Φ 22 x 22 mm	42/26	170 mm	Φ 22 x 22 mm		11
Φ 25 x 25 mm	42/27	180 mm	Φ 25 x 25 mm		10
Φ 30 x 30 mm	42/28	200 mm	Φ 30 x 30 mm		9

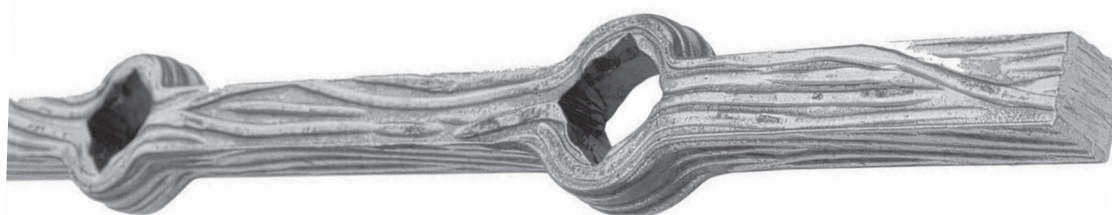

L 2000 mm



Sezione Section	Cod.art. Art.no.	Interasse Pitch	Foro Hole	Luce Distance	Numero Fori Holes Number
Φ 14 x 14 mm	605/5	140 mm	Φ 14 x 14 mm		14
Φ 16 x 16 mm	605/6	150 mm	Φ 16 x 16 mm		13
Φ 18 x 18 mm	605/7	160 mm	Φ 18 x 18 mm		12
Φ 20 x 20 mm	605/8	170 mm	Φ 20 x 20 mm		11



ARTEFERRO

L 2000 mm

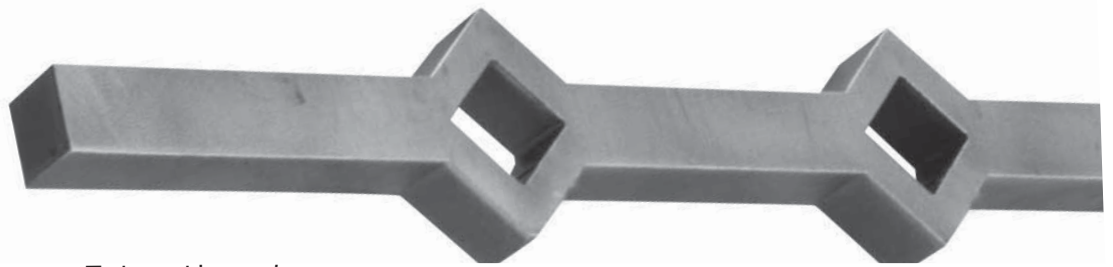

Tagliate al laser - Laser cut

Sezione Section	Cod.art. Art.no.	Interasse Pitch	Foro Hole	Luce Distance	Numero Fori Holes Number
□ 14 × 14 mm	1845/1		□ 15 × 15 mm	110 mm	14
□ 14 × 14 mm	1845/2		□ 15 × 15 mm	130 mm	13
□ 16 × 16 mm	1845/3		□ 17 × 17 mm	110 mm	12
□ 16 × 16 mm	1845/4		□ 17 × 17 mm	130 mm	11
□ 25 × 25 mm	1845/5		□ 26 × 26 mm	110 mm	14

L 2000 mm



Sezione Section	Cod.art. Art.no.	Interasse Pitch	Foro Hole	Luce Distance	Numero Fori Holes Number
□ 14 × 14 mm	42/15	140 mm	□ 14 × 14 mm		14
	42/A/9	124 mm	□ 14 × 14 mm	110 mm	14
□ 16 × 16 mm	42/16	150 mm	□ 16 × 16 mm		13
	42/A/10	126 mm	□ 16 × 16 mm	110 mm	14
□ 18 × 18 mm	42/17	160 mm	□ 18 × 18 mm		12
	42/A/11	128 mm	□ 18 × 18 mm	110 mm	14
□ 20 × 20 mm	42/18	170 mm	□ 20 × 20 mm		11
	42/A/12	130 mm	□ 20 × 20 mm	110 mm	14
□ 22 × 22 mm	42/19	170 mm	□ 22 × 22 mm		11
□ 25 × 25 mm	42/20	180 mm	□ 25 × 25 mm		10
□ 30 × 30 mm	42/21	200 mm	□ 30 × 30 mm		9

L 2000 mm



Sezione Section	Cod.art. Art.no.	Interasse Pitch	Foro Hole	Luce Distance	Numero Fori Holes Number
□ 14 × 14 mm	1845/16		∇ 18 × 15 mm	140 mm	11
□ 16 × 16 mm	1845/17		∇ 32 × 17 mm	150 mm	10
□ 18 × 18 mm	1845/18		∇ 34 × 19 mm	160 mm	9
□ 20 × 20 mm	1845/19		∇ 38 × 21 mm	170 mm	9



L 2000 mm



Sezione Section	Cod.art. Art.no.	Interasse Pitch	Foro Hole	Luce Distance	Numero Fori Holes Number
Φ 14 x 14 mm	I845/24	155 mm	Ø 15 mm	140 mm	11
Φ 16 x 16 mm	I845/25	167 mm	Ø 17 mm	150 mm	10
Φ 18 x 18 mm	I845/26	179 mm	Ø 19 mm	160 mm	9
Φ 20 x 20 mm	I845/27	191 mm	Ø 21 mm	170 mm	9

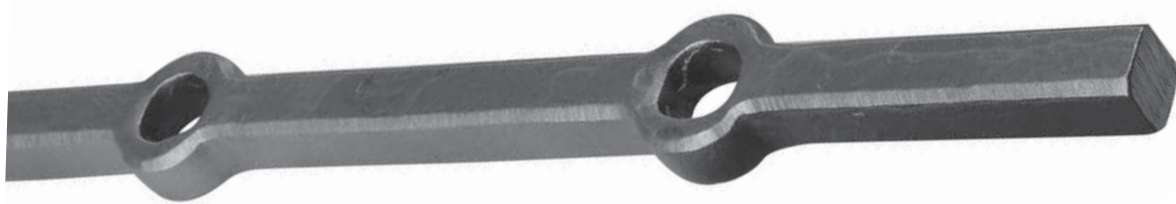

L 2000 mm



Sezione Section	Cod.art. Art.no.	Interasse Pitch	Foro Hole	Luce Distance	Numero Fori Holes Number
Φ 12 x 12 mm	GD124/1	120 mm	Ø 12 mm	108 mm	16
Φ 14 x 14 mm	GD124/2	140 mm	Ø 14 mm	126 mm	14
Φ 16 x 16 mm	GD124/3	150 mm	Ø 16 mm	134 mm	13
Φ 18 x 18 mm	GD124/4	160 mm	Ø 18 mm	142 mm	12
Φ 20 x 20 mm	GD124/5	170 mm	Ø 20 mm	150 mm	11
Φ 22 x 22 mm	GD124/6	170 mm	Ø 22 mm	148 mm	11
Φ 25 x 25 mm	GD124/7	180 mm	Ø 25 mm	155 mm	10
Φ 30 x 30 mm	GD124/8	200 mm	Ø 30 mm	170 mm	9



L 2000 mm



Tagliate al laser - Laser cut

Sezione Section	Cod.art. Art.no.	Interasse Pitch	Foro Hole	Luce Distance	Numero Fori Holes Number
Φ 14 x 14 mm	I845/11	95 mm	Ø 15 mm	110 mm	15
Φ 14 x 14 mm	I845/12	115 mm	Ø 15 mm	130 mm	12
Φ 16 x 16 mm	I845/13	93 mm	Ø 17 mm	110 mm	15
Φ 16 x 16 mm	I845/14	113 mm	Ø 17 mm	130 mm	12
Φ 25 x 25 mm	I845/15	116 mm	Ø 26 mm	110 mm	14

L 2000 mm
circa-approx.



A RICHIESTA
Disponibili qualsiasi lunghezza,
foro e sezione
UPON REQUEST
Available in any length, hole and section

Sezione Section	Foro Hole	Interasse Pitch	Luce Distance	Cod.art./Art.no.	Numero Fori Holes number	Lunghezza Length
☒ 30 x 8 mm	Ø 13 mm	112 mm	100 mm	1853/105	17	2004 mm
		127 mm	115 mm	1853/106	15	2020 mm
		142 mm	130 mm	1853/107	13	1976 mm
	Ø 15 mm	114 mm	100 mm	1853/108	16	1924 mm
		129 mm	115 mm	1853/109	14	1921 mm
		144 mm	130 mm	1853/110	13	2002 mm
	Ø 17 mm	116 mm	100 mm	1853/111	16	1956 mm
		131 mm	115 mm	1853/112	14	1949 mm
		146 mm	130 mm	1853/113	13	2028 mm
☒ 30 x 10 mm	Ø 13 mm	112 mm	100 mm	1853/114	17	2004 mm
		127 mm	115 mm	1853/115	15	2020 mm
		142 mm	130 mm	1853/116	13	1976 mm
	Ø 15 mm	114 mm	100 mm	1853/117	16	1924 mm
		129 mm	115 mm	1853/118	14	1921 mm
		144 mm	130 mm	1853/119	13	2002 mm
	Ø 17 mm	116 mm	100 mm	1853/120	16	1956 mm
		131 mm	115 mm	1853/121	14	1949 mm
		146 mm	130 mm	1853/122	13	2028 mm
☒ 35 x 8 mm	Ø 13 mm	112 mm	100 mm	1853/123	17	2004 mm
		127 mm	115 mm	1853/124	15	2020 mm
		142 mm	130 mm	1853/125	13	1976 mm
	Ø 15 mm	114 mm	100 mm	1853/126	16	1924 mm
		129 mm	115 mm	1853/127	14	1921 mm
		144 mm	130 mm	1853/128	13	2002 mm
	Ø 17 mm	116 mm	100 mm	1853/129	16	1956 mm
		131 mm	115 mm	1853/130	14	1949 mm
		146 mm	130 mm	1853/131	13	2028 mm
☒ 35 x 10 mm	Ø 13 mm	112 mm	100 mm	1853/132	17	2004 mm
		127 mm	115 mm	1853/133	15	2020 mm
		142 mm	130 mm	1853/134	13	1976 mm
	Ø 15 mm	114 mm	100 mm	1853/135	16	1924 mm
		129 mm	115 mm	1853/136	14	1921 mm
		144 mm	130 mm	1853/137	13	2002 mm
	Ø 17 mm	116 mm	100 mm	1853/138	16	1956 mm
		131 mm	115 mm	1853/139	14	1949 mm
		146 mm	130 mm	1853/140	13	2028 mm
☒ 40 x 8 mm	Ø 13 mm	112 mm	100 mm	1853/141	17	2004 mm
		127 mm	115 mm	1853/142	15	2020 mm
		142 mm	130 mm	1853/143	13	1976 mm
	Ø 15 mm	114 mm	100 mm	1853/144	16	1924 mm
		129 mm	115 mm	1853/145	14	1921 mm
		144 mm	130 mm	1853/146	13	2002 mm
	Ø 17 mm	116 mm	100 mm	1853/147	16	1956 mm
		131 mm	115 mm	1853/148	14	1949 mm
		146 mm	130 mm	1853/149	13	2028 mm
☒ 40 x 10 mm	Ø 13 mm	112 mm	100 mm	1853/150	17	2004 mm
		127 mm	115 mm	1853/151	15	2020 mm
		142 mm	130 mm	1853/152	13	1976 mm
	Ø 15 mm	114 mm	100 mm	1853/153	16	1924 mm
		129 mm	115 mm	1853/154	14	1921 mm
		144 mm	130 mm	1853/155	13	2002 mm
	Ø 17 mm	116 mm	100 mm	1853/156	16	1956 mm
		131 mm	115 mm	1853/157	14	1949 mm
		146 mm	130 mm	1853/158	13	2028 mm

BARRE FORATE - PIERCED BARS

L 2000 mm
circa-*approx.*

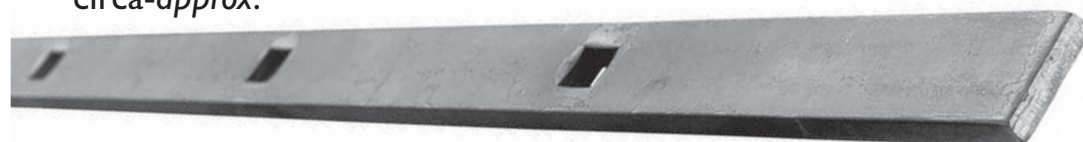

A RICHIESTA
Disponibili qualsiasi lunghezza,
foro e sezione
UPON REQUEST
Available in any length, hole and section

Sezione Section	Foro Hole	Interasse Pitch	Luce Distance	Cod.art./Art.no.	Numero Fori Holes number	Lunghezza Length
30 x 8 mm	13 x 13 mm	112 mm	100 mm	1853/1	17	2004 mm
		127 mm	115 mm	1853/2	15	2020 mm
		142 mm	130 mm	1853/3	13	1976 mm
	15 x 15 mm	114 mm	100 mm	608/6	16	1924 mm
		129 mm	115 mm	1853/4	14	1921 mm
		144 mm	130 mm	608/5	13	2002 mm
	17 x 17 mm	116 mm	100 mm	1853/5	16	1956 mm
		131 mm	115 mm	1853/6	14	1949 mm
		146 mm	130 mm	1853/7	13	2028 mm
30 x 10 mm	13 x 13 mm	112 mm	100 mm	1853/8	17	2004 mm
		127 mm	115 mm	1853/9	15	2020 mm
		142 mm	130 mm	1853/10	13	1976 mm
	15 x 15 mm	114 mm	100 mm	1853/11	16	1924 mm
		129 mm	115 mm	1853/12	14	1921 mm
		144 mm	130 mm	1853/13	13	2002 mm
	17 x 17 mm	116 mm	100 mm	1853/14	16	1956 mm
		131 mm	115 mm	1853/15	14	1949 mm
		146 mm	130 mm	1853/16	13	2028 mm
35 x 8 mm	13 x 13 mm	112 mm	100 mm	1853/17	17	2004 mm
		127 mm	115 mm	1853/18	15	2020 mm
		142 mm	130 mm	1853/19	13	1976 mm
	15 x 15 mm	114 mm	100 mm	1853/20	16	1924 mm
		129 mm	115 mm	1853/21	14	1921 mm
		144 mm	130 mm	1853/22	13	2002 mm
	17 x 17 mm	116 mm	100 mm	1853/23	16	1956 mm
		131 mm	115 mm	1853/24	14	1949 mm
		146 mm	130 mm	1853/25	13	2028 mm
35 x 10 mm	13 x 13 mm	112 mm	100 mm	1853/26	17	2004 mm
		127 mm	115 mm	1853/27	15	2020 mm
		142 mm	130 mm	1853/28	13	1976 mm
	15 x 15 mm	114 mm	100 mm	1853/29	16	1924 mm
		129 mm	115 mm	1853/30	14	1921 mm
		144 mm	130 mm	1853/31	13	2002 mm
	17 x 17 mm	116 mm	100 mm	1853/32	16	1956 mm
		131 mm	115 mm	1853/33	14	1949 mm
		146 mm	130 mm	1853/34	13	2028 mm
40 x 8 mm	13 x 13 mm	112 mm	100 mm	1853/35	17	2004 mm
		127 mm	115 mm	1853/36	15	2020 mm
		142 mm	130 mm	1853/37	13	1976 mm
	15 x 15 mm	114 mm	100 mm	608/8	16	1924 mm
		129 mm	115 mm	1853/38	14	1921 mm
		144 mm	130 mm	608/7	13	2002 mm
	17 x 17 mm	116 mm	100 mm	1853/39	16	1956 mm
		132 mm	115 mm	1853/40	14	1949 mm
		146 mm	130 mm	1853/41	13	2028 mm
40 x 10 mm	13 x 13 mm	112 mm	100 mm	1853/42	17	2004 mm
		127 mm	115 mm	1853/43	15	2020 mm
		142 mm	130 mm	1853/44	13	1976 mm
	15 x 15 mm	114 mm	100 mm	1853/45	16	1924 mm
		129 mm	115 mm	1853/46	14	1921 mm
		144 mm	130 mm	1853/47	13	2002 mm
	17 x 17 mm	116 mm	100 mm	1853/48	16	1956 mm
		131 mm	115 mm	1853/49	14	1949 mm
		146 mm	130 mm	1853/50	13	2028 mm

L 2000 mm
circa-approx.

A RICHIESTA
Disponibili qualsiasi lunghezza,
foro e sezione
UPON REQUEST
Available in any length, hole and section

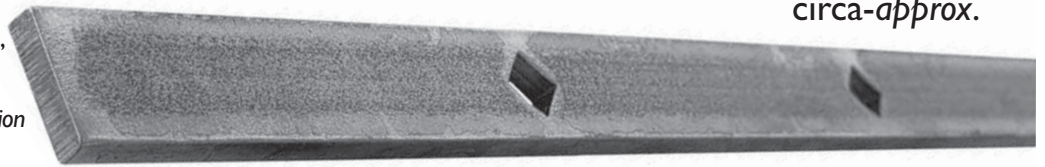





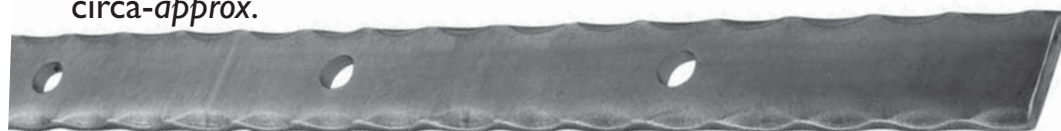

Sezione Section	Foro Hole	Interasse Pitch	Luce Distance	Cod.art./Art.no.	Numero Fori Holes number
∅ 30 x 8 mm	∅ 13 x 13 mm	112 mm	100 mm	1853/51	16
		127 mm	115 mm	1853/52	14
		142 mm	130 mm	1853/53	13
	∅ 15 x 15 mm	114 mm	100 mm	1853/54	16
		129 mm	115 mm	1853/55	14
		144 mm	130 mm	1853/56	12
	∅ 17 x 17 mm	116 mm	100 mm	1853/57	16
		131 mm	115 mm	1853/58	14
		146 mm	130 mm	1853/59	12
∅ 30 x 10 mm	∅ 13 x 13 mm	112 mm	100 mm	1853/60	16
		127 mm	115 mm	1853/61	14
		142 mm	130 mm	1853/62	13
	∅ 15 x 15 mm	114 mm	100 mm	1853/63	16
		129 mm	115 mm	1853/64	14
		144 mm	130 mm	1853/65	12
	∅ 17 x 17 mm	116 mm	100 mm	1853/66	16
		132 mm	115 mm	1853/67	14
		146 mm	130 mm	1853/68	12
∅ 35 x 8 mm	∅ 13 x 13 mm	112 mm	100 mm	1853/69	16
		127 mm	115 mm	1853/70	14
		142 mm	130 mm	1853/71	13
	∅ 15 x 15 mm	114 mm	100 mm	1853/72	16
		129 mm	115 mm	1853/73	14
		144 mm	130 mm	1853/74	12
	∅ 17 x 17 mm	116 mm	100 mm	1853/75	16
		131 mm	115 mm	1853/76	14
		146 mm	130 mm	1853/77	12
∅ 35 x 10 mm	∅ 13 x 13 mm	112 mm	100 mm	1853/78	16
		127 mm	115 mm	1853/79	14
		142 mm	130 mm	1853/80	13
	∅ 15 x 15 mm	114 mm	100 mm	1853/81	16
		129 mm	115 mm	1853/82	14
		144 mm	130 mm	1853/83	12
	∅ 17 x 17 mm	116 mm	100 mm	1853/84	16
		131 mm	115 mm	1853/85	14
		146 mm	130 mm	1853/86	12
∅ 40 x 8 mm	∅ 13 x 13 mm	112 mm	100 mm	1853/87	16
		127 mm	115 mm	1853/88	14
		142 mm	130 mm	1853/89	13
	∅ 15 x 15 mm	114 mm	100 mm	1853/90	16
		129 mm	115 mm	1853/91	14
		144 mm	130 mm	1853/92	12
	∅ 17 x 17 mm	116 mm	100 mm	1853/93	16
		131 mm	115 mm	1853/94	14
		146 mm	130 mm	1853/95	12
∅ 40 x 10 mm	∅ 13 x 13 mm	112 mm	100 mm	1853/96	16
		127 mm	115 mm	1853/97	14
		142 mm	130 mm	1853/98	13
	∅ 15 x 15 mm	114 mm	100 mm	1853/99	16
		129 mm	115 mm	1853/100	14
		144 mm	130 mm	1853/101	12
	∅ 17 x 17 mm	116 mm	100 mm	1853/102	16
		132 mm	115 mm	1853/103	14
		146 mm	130 mm	1853/104	12

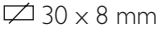
L 2000 mm
circa-*approx.*

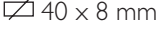



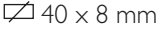

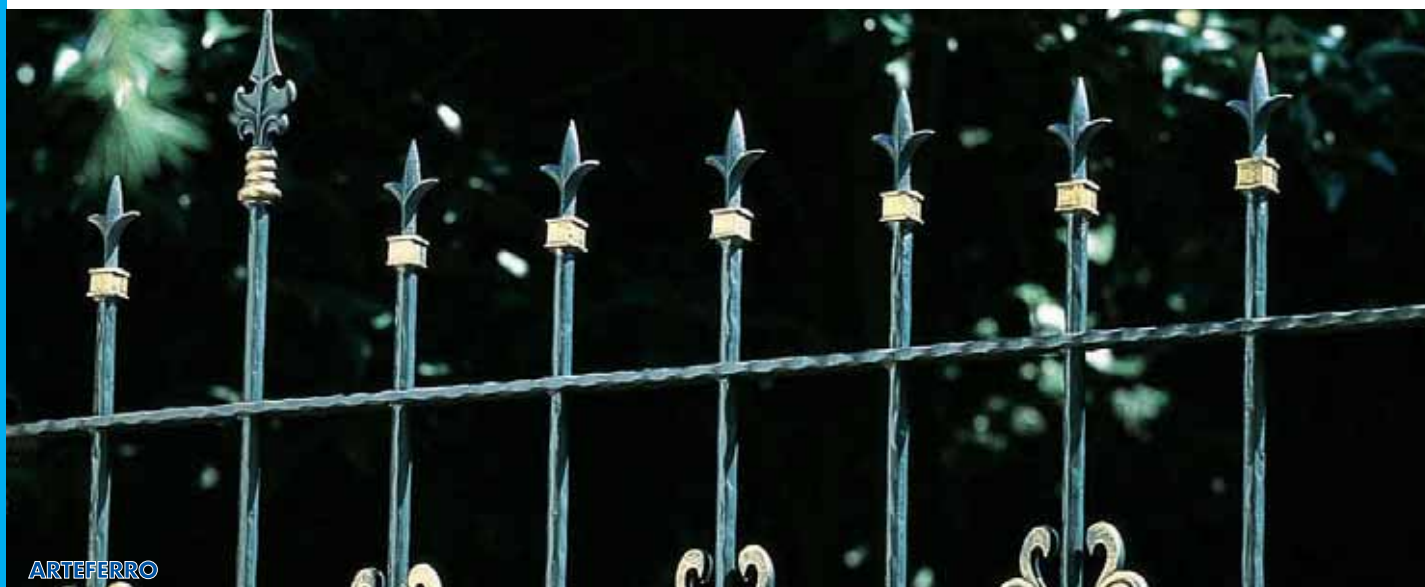



A RICHIESTA
Disponibili qualsiasi lunghezza,
foro e sezione
UPON REQUEST
Available in any length, hole and section

Sezione Section	Foro Hole	Interasse Pitch	Luce Distance	Cod.art./Art.no.	Numero Fori Holes number	Lunghezza Length
 FORO HOLE  30 x 8 mm	\square 13 x 13 mm	112 mm	100 mm	1853/159	17	2004 mm
		127 mm	115 mm	1853/160	15	2020 mm
		142 mm	130 mm	1853/161	13	1976 mm
	\square 15 x 15 mm	114 mm	100 mm	1853/162	16	1924 mm
		129 mm	115 mm	1853/163	14	1921 mm
		147 mm	130 mm	1853/164	13	2002 mm
	\square 17 x 17 mm	116 mm	100 mm	1853/165	16	1956 mm
		131 mm	115 mm	1853/166	14	1949 mm
		146 mm	130 mm	1853/167	13	2028 mm
 FORO HOLE  40 x 8 mm	\square 13 x 13 mm	112 mm	100 mm	1853/168	17	2004 mm
		127 mm	115 mm	1853/169	15	2020 mm
		142 mm	130 mm	1853/170	13	1976 mm
	\square 15 x 15 mm	114 mm	100 mm	1853/171	16	1924 mm
		129 mm	115 mm	1853/172	14	1921 mm
		147 mm	130 mm	1853/173	13	2002 mm
	\square 17 x 17 mm	116 mm	100 mm	1853/174	16	1956 mm
		131 mm	115 mm	1853/175	14	1949 mm
		146 mm	130 mm	1853/176	13	2028 mm
 FORO HOLE  30 x 8 mm	\circ 13 x 13 mm	112 mm	100 mm	1853/177	17	2004 mm
		127 mm	115 mm	1853/178	15	2020 mm
		142 mm	130 mm	1853/179	13	1976 mm
	\circ 15 x 15 mm	114 mm	100 mm	1853/180	16	1924 mm
		129 mm	115 mm	1853/181	14	1921 mm
		147 mm	130 mm	1853/182	13	2002 mm
	\circ 17 x 17 mm	116 mm	100 mm	1853/183	16	1956 mm
		131 mm	115 mm	1853/184	14	1949 mm
		146 mm	130 mm	1853/185	13	2028 mm
 FORO HOLE  40 x 8 mm	\circ 13 x 13 mm	112 mm	100 mm	1853/186	17	2004 mm
		127 mm	115 mm	1853/187	15	2020 mm
		142 mm	130 mm	1853/188	13	1976 mm
	\circ 15 x 15 mm	114 mm	100 mm	1853/189	16	1924 mm
		129 mm	115 mm	1853/190	14	1921 mm
		147 mm	130 mm	1853/191	13	2002 mm
	\circ 17 x 17 mm	116 mm	100 mm	1853/192	16	1956 mm
		131 mm	115 mm	1853/193	14	1949 mm
		146 mm	130 mm	1853/194	13	2028 mm



A RICHIESTA
Disponibili qualsiasi lunghezza,
foro e sezione
UPON REQUEST
Available in any length, hole and section



Sezione Section	Foro Hole	Interasse Pitch	Luce Distance	Cod.art./Art.no.	Numero Fori Holes number	Lunghezza Length
 FORO HOLE  30 x 8 mm	Φ 13 x 13 mm	112 mm	100 mm	1853/195	17	2004 mm
		127 mm	115 mm	1853/196	15	2020 mm
		142 mm	130 mm	1853/197	13	1976 mm
	Φ 15 x 15 mm	114 mm	100 mm	1853/198	16	1924 mm
		129 mm	115 mm	1853/199	14	1921 mm
		147 mm	130 mm	1853/200	13	2002 mm
	Φ 17 x 17 mm	116 mm	100 mm	1853/201	16	1956 mm
		131 mm	115 mm	1853/202	14	1949 mm
		146 mm	130 mm	1853/203	13	2028 mm
 FORO HOLE  40 x 8 mm	Φ 13 x 13 mm	112 mm	100 mm	1853/204	17	2004 mm
		127 mm	115 mm	1853/205	15	2020 mm
		142 mm	130 mm	1853/206	13	1976 mm
	Φ 15 x 15 mm	114 mm	100 mm	1853/207	16	1924 mm
		129 mm	115 mm	1853/208	14	1921 mm
		147 mm	130 mm	1853/209	13	2002 mm
	Φ 17 x 17 mm	116 mm	100 mm	1853/210	16	1956 mm
		131 mm	115 mm	1853/211	14	1949 mm
		146 mm	130 mm	1853/212	13	2028 mm
 FORO HOLE  30 x 8 mm	Φ 13 x 13 mm	112 mm	100 mm	1853/213	17	2004 mm
		127 mm	115 mm	1853/214	15	2020 mm
		142 mm	130 mm	1853/215	13	1976 mm
	Φ 15 x 15 mm	114 mm	100 mm	1853/216	16	1924 mm
		129 mm	115 mm	1853/217	14	1921 mm
		147 mm	130 mm	1853/218	13	2002 mm
	Φ 17 x 17 mm	116 mm	100 mm	1853/219	16	1956 mm
		131 mm	115 mm	1853/220	14	1949 mm
		146 mm	130 mm	1853/221	13	2028 mm
 FORO HOLE  40 x 8 mm	Φ 13 x 13 mm	112 mm	100 mm	1853/222	17	2004 mm
		127 mm	115 mm	1853/223	15	2020 mm
		142 mm	130 mm	1853/224	13	1976 mm
	Φ 15 x 15 mm	114 mm	100 mm	1853/225	16	1924 mm
		129 mm	115 mm	1853/226	14	1921 mm
		147 mm	130 mm	1853/227	13	2002 mm
	Φ 17 x 17 mm	116 mm	100 mm	1853/228	16	1956 mm
		131 mm	115 mm	1853/229	14	1949 mm
		146 mm	130 mm	1853/230	13	2028 mm





L 2000 mm
circa-*approx.*

Sezione Section	Foro Hole	Interasse Pitch	Luce Distance	Cod.art./Art.no.	Numero Fori Holes Number
30 x 15 mm	18 x 18 mm	140 mm	122 mm	1360/10	14
30 x 20 mm	18 x 18 mm	140 mm	122 mm	1360/11	14



L 2000 mm
circa-*approx.*

Sezione Section	Foro Hole	Interasse Pitch	Luce Distance	Cod.art./Art.no.	Numero Fori Holes Number
30 x 15 mm	Ø 20 mm	140 mm	120 mm	1360/8	14
30 x 20 mm	Ø 20 mm	140 mm	120 mm	1360/9	14



L 2000 mm
circa-*approx.*

Sezione Section	Foro Hole	Interasse Pitch	Luce Distance	Cod.art./Art.no.	Numero Fori Holes Number
40 x 8 mm	15 x 15 mm		120 mm	1360/12	13
40 x 8 mm	17 x 17 mm		120 mm	1360/13	15

L 2000 mm
circa-*approx.*

Barre con ribattini stampati - Bars with stamped rivets



Sezione Section	Ribattino Rivet	Interasse Pitch 112 mm	Interasse Pitch 122 mm	Interasse Pitch 127 mm	Interasse Pitch 132 mm
		Cod.art./Art.no.	Cod.art./Art.no.	Cod.art./Art.no.	Cod.art./Art.no.
30 x 8 mm	Ø 11 mm	1852/1	1852/2	1852/3	1852/4
40 x 8 mm	Ø 16 mm	1852/5	1852/6	1852/7	1852/8

L 2000 mm
circa-*approx.*

Barre con ribattini stampati - Bars with stamped rivets



Sezione Section	Ribattino Rivet	Interasse Pitch 112 mm	Interasse Pitch 122 mm	Interasse Pitch 127 mm	Interasse Pitch 132 mm
		Cod.art./Art.no.	Cod.art./Art.no.	Cod.art./Art.no.	Cod.art./Art.no.
25 x 6 mm	Ø 16 mm	1852/9	1852/10	1852/11	1852/12
25 x 8 mm	Ø 16 mm	1852/13	1852/14	1852/15	1852/16
30 x 6 mm	Ø 16 mm	1852/17	1852/18	1852/19	1852/20

L 2000 mm
circa-*approx.*

Barre con ribattini stampati - Bars with stamped rivets



Sezione Section	Ribattino Rivet	Interasse Pitch 112 mm	Interasse Pitch 122 mm	Interasse Pitch 127 mm	Interasse Pitch 132 mm
		Cod.art./Art.no.	Cod.art./Art.no.	Cod.art./Art.no.	Cod.art./Art.no.
25 x 6 mm	Ø 16 mm	1852/25	1852/26	1852/27	1852/28
25 x 8 mm	Ø 16 mm	1852/29	1852/30	1852/31	1852/32
30 x 6 mm	Ø 16 mm	1852/33	1852/34	1852/35	1852/36
30 x 8 mm	Ø 16 mm	1852/37	1852/38	1852/39	1852/40



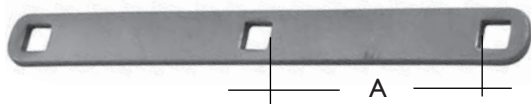

Cod.art./Art.no.	Sezione Section	Foro Hole	Luce A Distance A	Luce B Distance B	Lunghezza Length
GDI28/49	25 x 6 mm	12 x 12 mm	100 mm	-	250 mm
GDI28/57	25 x 6 mm	Ø 14 mm	100 mm	-	260 mm
GDI28/53	30 x 6 mm	14 x 14 mm	100 mm	-	260 mm
GDI28/61	30 x 6 mm	Ø 14 mm	100 mm	-	260 mm

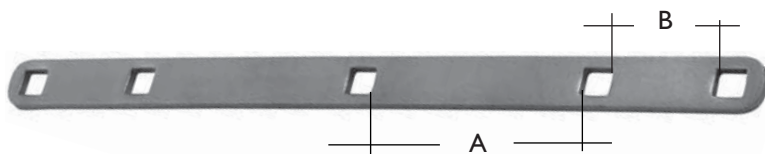

Cod.art./Art.no.	Sezione Section	Foro Hole	Luce A Distance A	Luce B Distance B	Lunghezza Length
GDI28/50	25 x 6 mm	12 x 12 mm	100 mm	50 mm	375 mm
GDI28/58	25 x 6 mm	Ø 14 mm	100 mm	50 mm	375 mm
GDI28/54	30 x 6 mm	14 x 14 mm	100 mm	50 mm	385 mm
GDI28/62	30 x 6 mm	Ø 14 mm	100 mm	50 mm	385 mm

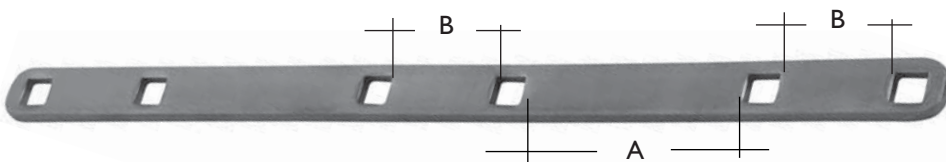

Cod.art./Art.no.	Sezione Section	Foro Hole	Luce A Distance A	Luce B Distance B	Lunghezza Length
GDI28/61	25 x 6 mm	12 x 12 mm	100 mm	50 mm	435 mm
GDI28/59	25 x 6 mm	Ø 14 mm	100 mm	50 mm	435 mm
GDI28/55	30 x 6 mm	14 x 14 mm	100 mm	50 mm	450 mm
GDI28/63	30 x 6 mm	Ø 14 mm	100 mm	50 mm	450 mm

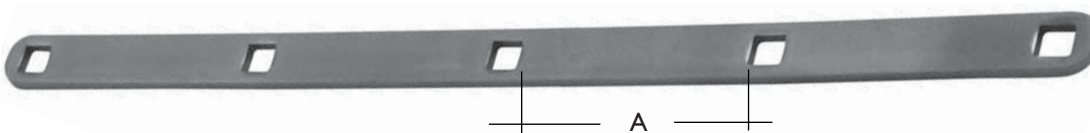

Cod.art./Art.no.	Sezione Section	Foro Hole	Luce A Distance A	Luce B Distance B	Lunghezza Length
GDI28/52	25 x 6 mm	12 x 12 mm	100 mm	-	475 mm
GDI28/60	25 x 6 mm	Ø 14 mm	100 mm	-	475 mm
GDI28/56	30 x 6 mm	14 x 14 mm	100 mm	-	485 mm
GDI28/64	30 x 6 mm	Ø 14 mm	100 mm	-	485 mm

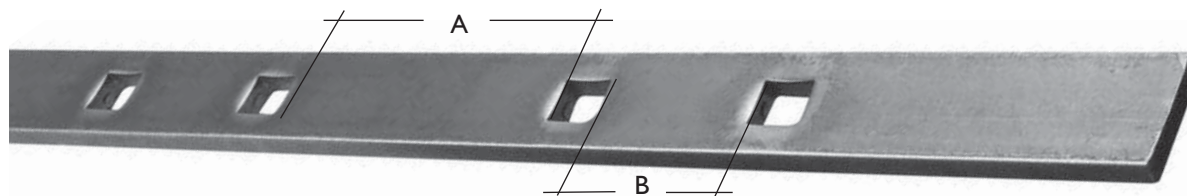

Cod.art./Art.no.	Sezione Section	Foro Hole	Luce A Distance A	Numero spazi A No. of A spaces	Luce B Distance B	Numero spazi B No. of B spaces	Lunghezza Length
GD128/1	25 x 8 mm	13 x 13 mm	100 mm	11	65 mm	10	2000 mm
GD128/25		Ø 13 mm	100 mm	11	65 mm	10	2000 mm
GD128/2		13 x 13 mm	115 mm	10	70 mm	9	2000 mm
GD128/26		Ø 13 mm	115 mm	10	70 mm	9	2000 mm
GD128/3		15 x 15 mm	130 mm	9	75 mm	8	2000 mm
GD128/27		Ø 15 mm	130 mm	9	75 mm	8	2000 mm
GD128/13		15 x 15 mm	100 mm	11	60 mm	10	2000 mm
GD128/37		Ø 15 mm	100 mm	11	60 mm	10	2000 mm
GD128/14		15 x 15 mm	115 mm	10	65 mm	9	2000 mm
GD128/38		Ø 15 mm	115 mm	10	65 mm	9	2000 mm
GD128/15		15 x 15 mm	130 mm	9	70 mm	8	2000 mm
GD128/39		Ø 15 mm	130 mm	9	70 mm	8	2000 mm
GD128/4		30 x 8 mm	13 x 13 mm	100 mm	11	65 mm	10
GD128/28	Ø 13 mm		100 mm	11	65 mm	10	2000 mm
GD128/5	13 x 13 mm		115 mm	10	70 mm	9	2000 mm
GD128/29	Ø 13 mm		115 mm	10	70 mm	9	2000 mm
GD128/6	15 x 15 mm		130 mm	9	75 mm	8	2000 mm
GD128/30	Ø 15 mm		130 mm	9	75 mm	8	2000 mm
GD128/16	15 x 15 mm		100 mm	11	60 mm	10	2000 mm
GD128/40	Ø 15 mm		100 mm	11	60 mm	10	2000 mm
GD128/17	15 x 15 mm		115 mm	10	65 mm	9	2000 mm
GD128/41	Ø 15 mm		115 mm	10	65 mm	9	2000 mm
GD128/18	15 x 15 mm		130 mm	9	70 mm	8	2000 mm
GD128/42	Ø 15 mm	130 mm	9	70 mm	8	2000 mm	
GD128/7	35 x 8 mm	13 x 13 mm	100 mm	11	65 mm	10	2000 mm
GD128/31		Ø 13 mm	100 mm	11	65 mm	10	2000 mm
GD128/8		13 x 13 mm	115 mm	10	70 mm	9	2000 mm
GD128/32		Ø 13 mm	115 mm	10	70 mm	9	2000 mm
GD128/9		15 x 15 mm	130 mm	9	75 mm	8	2000 mm
GD128/33		Ø 15 mm	130 mm	9	75 mm	8	2000 mm
GD128/19		15 x 15 mm	100 mm	11	60 mm	10	2000 mm
GD128/43		Ø 15 mm	100 mm	11	60 mm	10	2000 mm
GD128/20		15 x 15 mm	115 mm	10	65 mm	9	2000 mm
GD128/44		Ø 15 mm	115 mm	10	65 mm	9	2000 mm
GD128/21		15 x 15 mm	130 mm	9	70 mm	8	2000 mm
GD128/45		Ø 15 mm	130 mm	9	70 mm	8	2000 mm
GD128/10		40 x 8 mm	13 x 13 mm	100 mm	11	65 mm	10
GD128/34	Ø 13 mm		100 mm	11	65 mm	10	2000 mm
GD128/11	13 x 13 mm		115 mm	10	70 mm	9	2000 mm
GD128/35	Ø 13 mm		115 mm	10	70 mm	9	2000 mm
GD128/12	15 x 15 mm		130 mm	9	75 mm	8	2000 mm
GD128/36	Ø 15 mm		130 mm	9	75 mm	8	2000 mm
GD128/22	15 x 15 mm		100 mm	11	60 mm	10	2000 mm
GD128/46	Ø 15 mm		100 mm	11	60 mm	10	2000 mm
GD128/23	15 x 15 mm		115 mm	10	65 mm	9	2000 mm
GD128/47	Ø 15 mm		115 mm	10	65 mm	9	2000 mm
GD128/24	15 x 15 mm		130 mm	9	70 mm	8	2000 mm
GD128/48	Ø 15 mm		130 mm	9	70 mm	8	2000 mm

foro/hole
Ø 14 mm

Art. 608/1
interasse/pitch 130 mm
n. 13 fori/holes

Art. 608/2
interasse/pitch 100 mm
n. 13 fori/holes

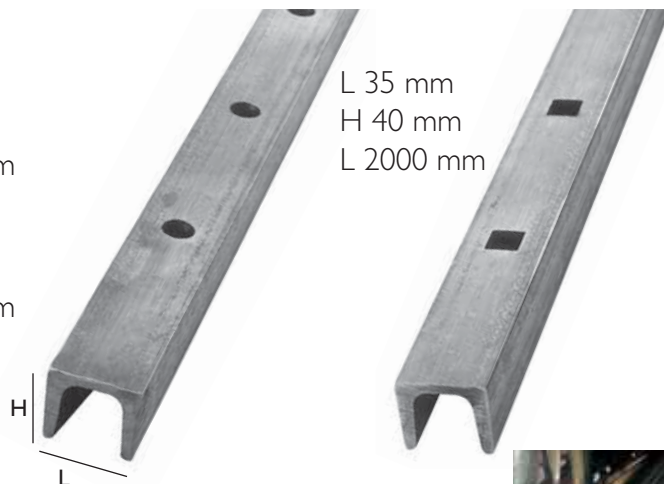

foro/hole
Ø 14 x 14 mm

Art. 608/3
interasse / pitch 130 mm
n. 13 fori/holes

Art. 608/4
interasse / pitch 100 mm
n. 15 fori/holes



Art. 611/12

L 1850 mm
n. 13 borchie/bushes

Art. 611/11

L 1590 mm
n. 11 borchie / bushes

Art. 611/10

L 1330 mm
n. 9 borchie / bushes

Art. 611/9

L 1070 mm
n. 7 borchie / bushes

Art. 611/8

L 810 mm
n. 5 borchie / bushes

Art. 611/7

L 550 mm
n. 3 borchie / bushes

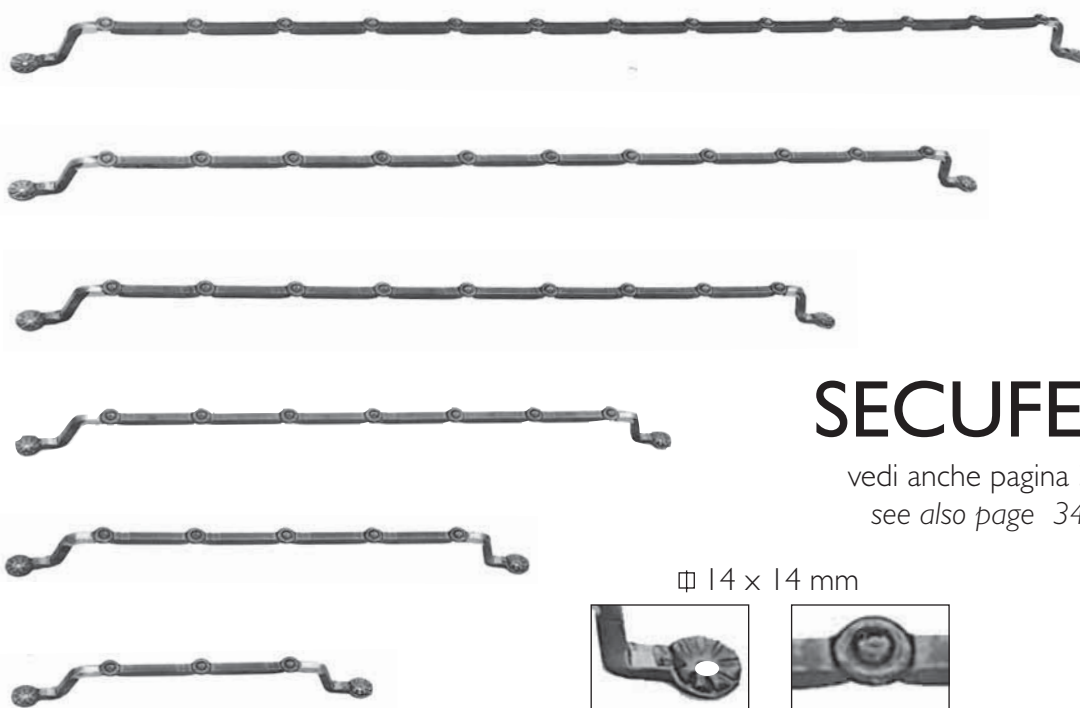

SECUFER®

vedi anche pagina 348
see also page 348

Ø 14 x 14 mm





Art. 614/4
 \square 14 x 14 mm
 interasse/pitch 125 mm
 L 2000 mm
 n. 15 borchie / bushes

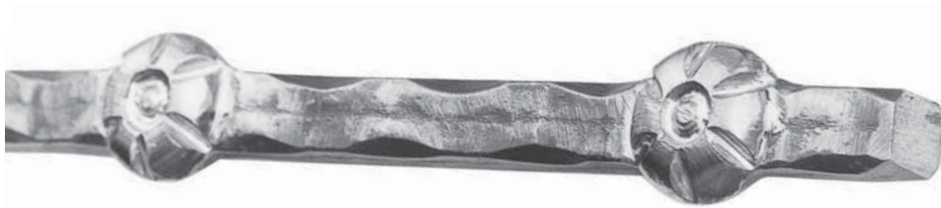

Art. 614/5
 \square 14 x 14 mm
 interasse/pitch 125 mm
 L 2000 mm
 n. 15 borchie/bushes

Art. 611/1

L 570 mm
 n. 3 borchie/bushes

Art. 611/2

L 830 mm
 n. 5 borchie/bushes

Art. 611/3

L 1090 mm
 n. 7 borchie/bushes

Art. 611/4

L 1350 mm
 n. 9 borchie/bushes

Art. 611/5

L 1610 mm
 n. 11 borchie/bushes

Art. 611/6

L 1870 mm
 n. 13 borchie/bushes

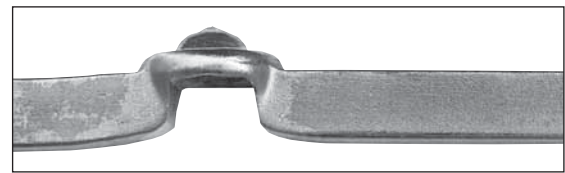



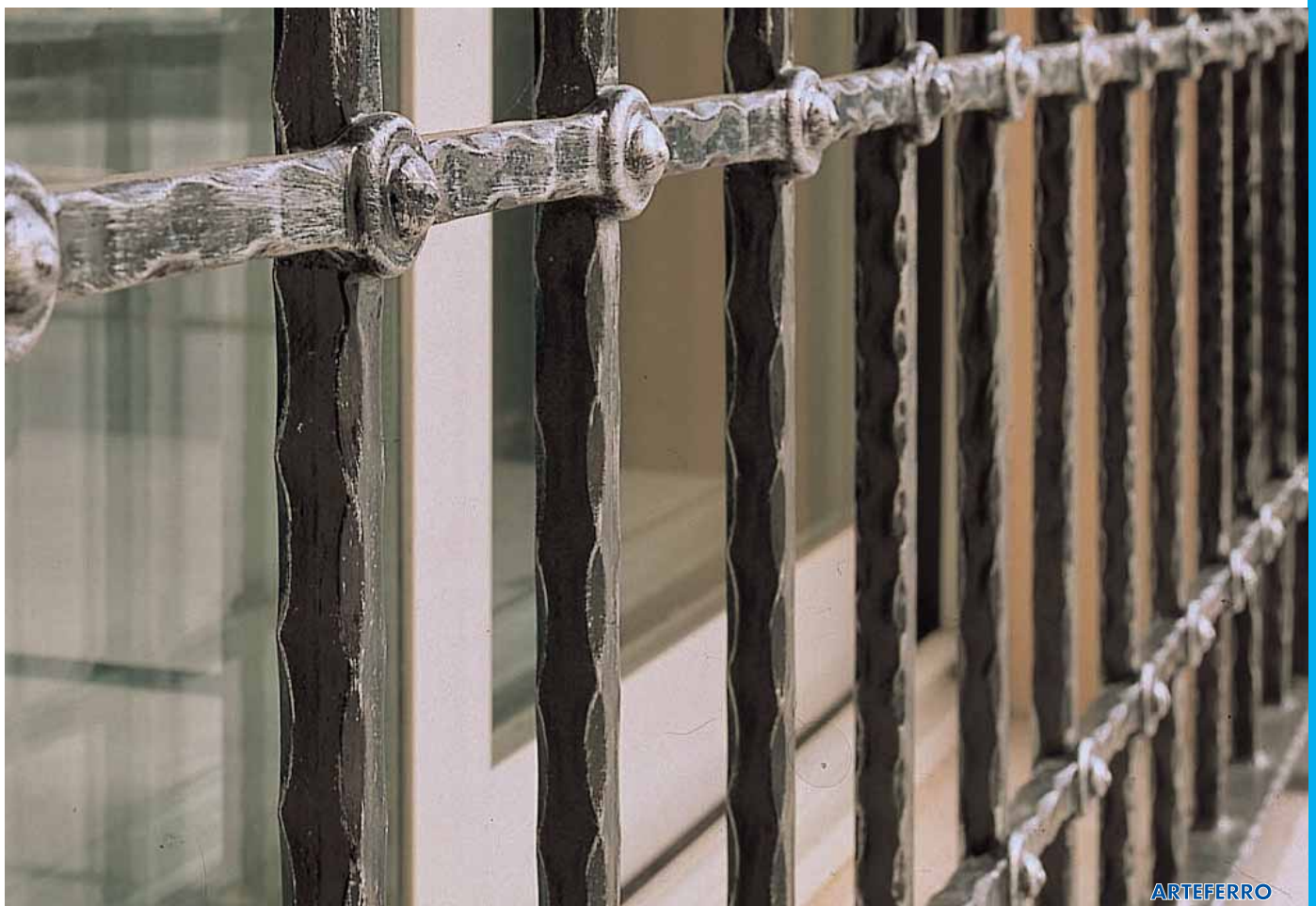

Art. 614/6

\square 14 x 14 mm
 interasse/pitch 125 mm
 L 2000 mm
 n. 15 borchie / bushes

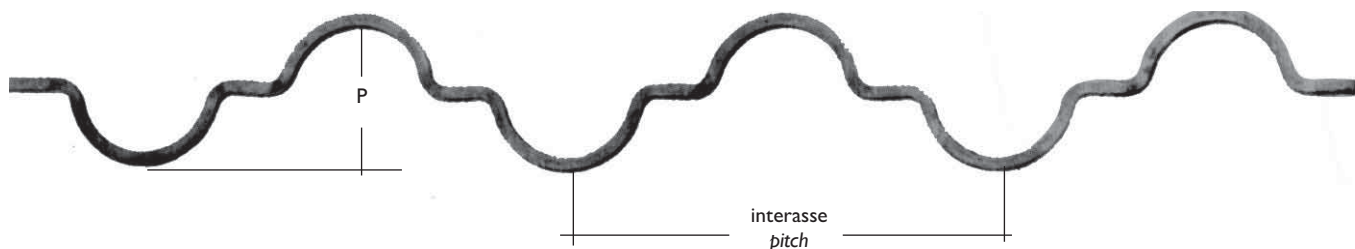

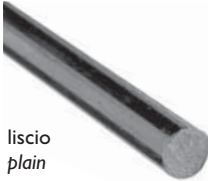
BARRE FORATE - PIERCED BARS

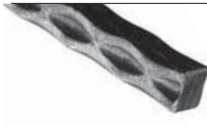

	Sezione Section	Cod.art./Art.no.	interasse Pitch	P	Lunghezza Length
 liscio plain	⌀ 8 x 8 mm	38/1	240 mm	84 mm	1600 mm
	▧ 12 x 6 mm	38/2	240 mm	80 mm	1600 mm
	⌀ 10 x 10 mm	38/3	250 mm	95 mm	1600 mm
	⌀ 12 x 12 mm	38/4	260 mm	100 mm	1600 mm
	⌀ 10 mm	1846/1	180 mm	100 mm	2000 mm
 spigolato hammered on edges	⌀ 12 x 12 mm	621/1	260 mm	100 mm	1600 mm
 corteccia three bark effect	⌀ 12 x 12 mm	1358/1	260 mm	100 mm	1600 mm
	⌀ 12 x 12 mm	1358/2	260 mm	100 mm	1600 mm
	⌀ 12 x 12 mm	620/1	260 mm	100 mm	1600 mm

L 6000 mm - interasse/pitch 178 mm  STAMPATE SULLO SPIGOLO STAMPED ON EDGE



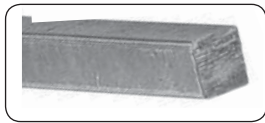

Art. 39/1 - $\Phi 8 \times 8$ mm - L 1600 mm
Lato interno - *Internal square* A = 120 mm

Art. 39/2 - $\Phi 8 \times 8$ mm - L 1600 mm
Lato interno - *Internal square* A = 160 mm

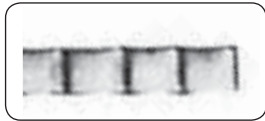

Art. 597/5 - $\square 16 \times 8$ mm - L 1600 mm

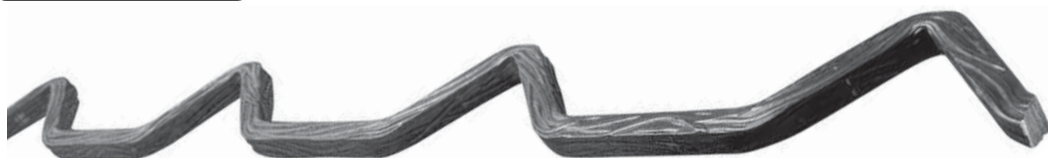

Art. 1356/2 - $\Phi 12 \times 12$ mm - L 1750 mm
A = 75 mm - B = 220 mm

Art. 1358/3 - $\Phi 12 \times 12$ mm - L 1600 mm
A = 75 mm - B = 220 mm



Art. 1356/1 - $\Phi 12 \times 12$ mm - L 1750 mm
A = 75 mm - B = 220 mm

Art. 1358/4 - $\Phi 12 \times 12$ mm - L 1600 mm
A = 75 mm - B = 220 mm

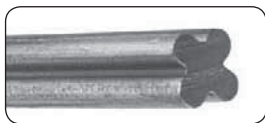

Art. 1356/3 - $\Phi 12 \times 12$ mm - L 1750 mm
A = 75 mm - B = 220 mm

Art. 1358/5 - $\Phi 12 \times 12$ mm - L 1600 mm
A = 75 mm - B = 220 mm

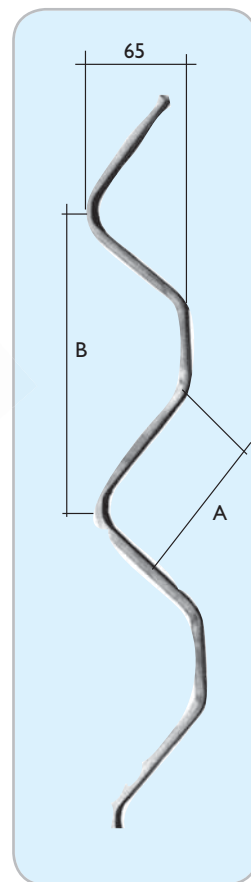

ARTEFERRO

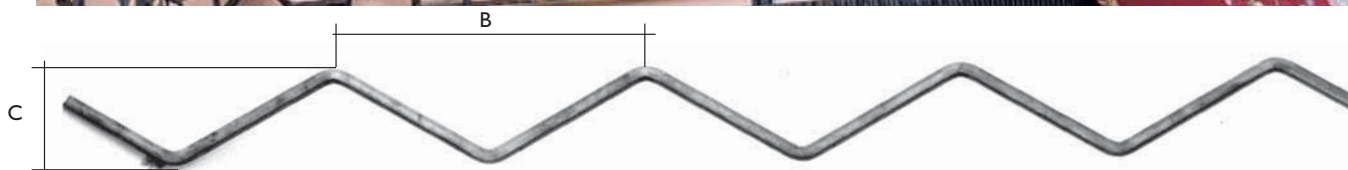

Art. 40/B/3
 $\Phi 12 \times 12$ mm
Art. 40/B/4
 $\Phi 8 \times 8$ mm

Art. 40/B/5
 $\square 12 \times 6$ mm
Art. 40/B/6
 $\Phi 10 \times 10$ mm

Art. 40/B/7
 $\Phi 14 \times 14$ mm

L 2000 mm
B = 300 mm
C = 91 mm

A

Art. 41/2
 \square 30 x 8 mm
 L 2000 mm



B

Art. 41/3
 \square 30 x 8 mm
 L 2000 mm

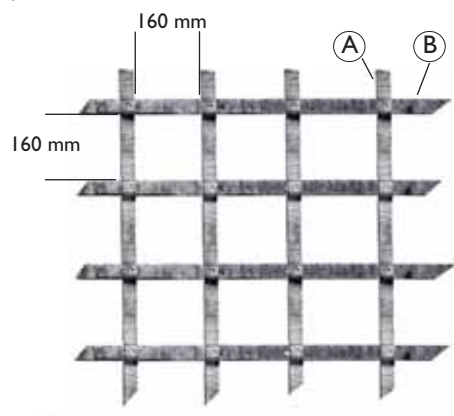

Art. 135/3
 \square 16 x 16 mm
 H 650 mm
 foro hole 16 x 16 mm

fori - holes \square 14 x 14 mm

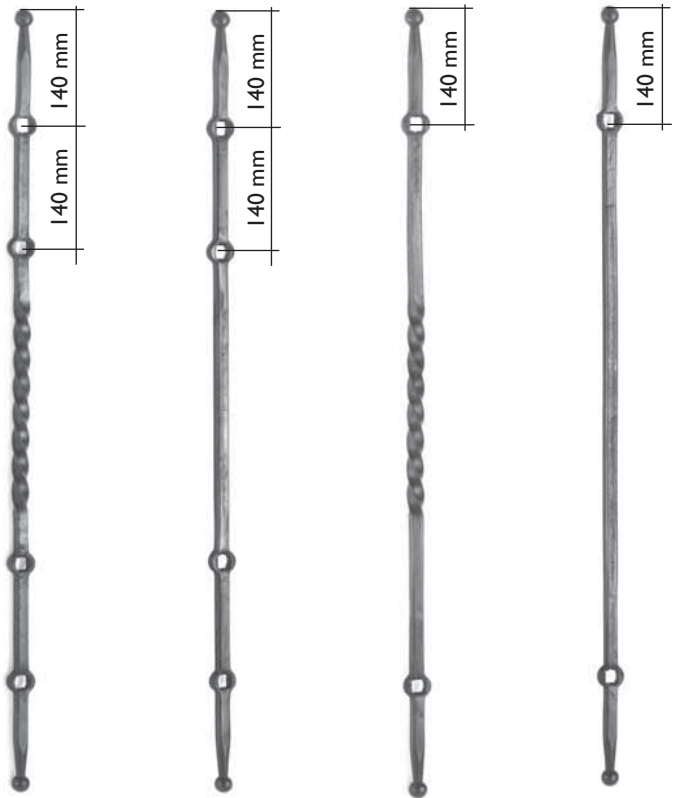

Art. 42/B/1 \square 14 x 14 mm H 900 mm
Art. 42/B/2 \square 14 x 14 mm H 900 mm
Art. 42/B/3 \square 14 x 14 mm H 700 mm
Art. 42/B/4 \square 14 x 14 mm H 700 mm



ARTEFERRO

PIANTONI FORATI a CALDO *HOT PIERCED NEWEL POSTS*

Foro/Hole per/for \varnothing 30 mm

PRODUCIBILI ANCHE SU MISURA E CON FORI OVALI
DIFFERENT SIZES AND WITH OVAL HOLES ON DEMAND



H 1100 mm

Art. 200/1

\varnothing 40 x 40 mm

Art. 200/3

\varnothing 30 x 30 mm

H 1200 mm

Art. 200/11

\varnothing 40 x 40 mm

Art. 200/12

\varnothing 30 x 30 mm

H 1200 mm

Art. 200/13

\varnothing 40 x 40 mm

Art. 200/14

\varnothing 30 x 30 mm

H 1200 mm

Art. 200/15

\varnothing 40 x 40 mm

Art. 200/16

\varnothing 30 x 30 mm

H 1100 mm

Art. 200/8

\varnothing 40 x 40 mm

Art. 200/9

\varnothing 30 x 30 mm

H 1100 mm

Art. 200/6

\varnothing 40 x 40 mm

sfera/sphere \varnothing 80 mm

Art. 200/7

\varnothing 30 x 30 mm

sfera/sphere \varnothing 70 mm



PRODUCIBILI ANCHE SU MISURA E CON FORI OVALI
DIFFERENT SIZES AND WITH OVAL HOLES ON DEMAND



interasse/pitch 450 mm
fori/holes Ø 31 mm
H 1100 mm
Art. 200/4
Ø 40 mm
Art. 200/5
Ø 30 mm



interasse/pitch 320 mm
fori/holes Ø 31 mm
H 1200 mm
Art. 200/17
Ø 40 mm
Art. 200/18
Ø 30 mm



interasse/pitch 450 mm
fori/holes Ø 31 mm
H 1200 mm
Art. 200/19
Ø 40 mm
Art. 200/20
Ø 30 mm



interasse/pitch 320 mm
fori/holes Ø 31 mm
H 1200 mm
Art. 200/21
Ø 40 mm
Art. 200/22
Ø 30 mm





Via Vicenza, 6/14
36034 Malo (Vicenza) ITALY
TEL. (+39) 0445 580 580
FAX (+39) 0445 580 874
E-mail: india@arteferro.com
www.arteferro.com - www.arteferroinox.com
www.ilgrandefabbro.com - www.ironews.com



HOUSTON - U.S.A.

7947 MESA ROAD - HOUSTON
TEXAS 77028 - U.S.A.
PHONE: (+1) (713) 694-6065 / 1-800-772-4706
FAX: (+1) (713) 694-2055
www.indital.com - forgings@indital.com



MIAMI - U.S.A.

2955 N.W. 75th STREET
MIAMI, FLORIDA 33147 - USA
PHONE: (+1) (305) 836-9232 / 1-877-723-6743
FAX: (+1) (305) 836-4113
www.arteferromiami.com info@arteferromiami.com



AVELLINO - ITALY

Via Piano Alvanella 83024 MONTEFORTE IRPINO (AV)
Tel. (+39) 0825 68 00 81
Fax (+39) 0825 68 34 98
(Per Campania - Puglia - Calabria - Basilicata - Molise)
www.arteferrosud.it info@arteferrosud.it



FRANCE

Z.A.E. LA BAUME RN 113 - 34290 SERVIAN FRANCE
TEL. (+33) (0) 4.67.39.42.81 (lignes groupées)
Fax (+33) (0) 4.67.39.20.90
www.franceindia.com
france.india@wanadoo.fr



SPAIN

28500 ARGANDA DEL REY (MADRID) - ESPAÑA
C/ ABEDUL, 43 - Poligono "EL GUIJAR"
TEL. (+34) (91) 8701897 - 8700819
FAX (+34) (91) 8700820
info@arteferro.es www.arteferro.es



CROATIA

SIRKOVISCE bb 40324 GORICAN - HRVATSKA
PHONE (+385) (0)40 602 - 222
Fax PHONE (+385) (0)40 602-230
www.arteferro-dohomont.hr
info@arteferro-dohomont.hr



ROMANIA

Targoviste - Romania Soseaua Gaesti, (sat Colanu)
Judetul Dambovitza
Tel. (004) 0751060204, (004) 0745395590
Fax (004) 0745731210
E-mail: info@mobillforge.com



РОССИЯ

603092 Nizhny Novgorod (Russia)
Moskovskoje shosse, 320 B
TEL. (+7) (831) 296-19-99 FAX: (+7) (831) 279-28-63
www.arteferro.ru - info@arteferrorussia.com



UKRAINE

5, AVTOPARKOVA, 02660 Kiev - Ukraine
Tel.: (+38) (044) 4920331
Fax: (+38) (044) 4920332
E-mail: arteferroukraina@svitonline.com
www.arteferroukraina.com



POLAND

ul. Gierdziewskiego 7
02-495 Warszawa POLAND
Tel +48 (22) 397-79-40
Fax +48 (22) 397-21-55
info@indiapoland.com - www.indiapoland.com



MEXICO

Av. E. Martinez Lara # 117 Parque Industrial MILIMEX
Carretera Sta. Rosa Km. 3 Apodaca,
Nuevo León C.P. 66637
Teléfono: (81) 1295-5094 / 1295-5095 - Fax: (81) 1295-5097
info@arteferromonterrey.com www.arteferromonterrey.com



BRASIL

RUA PADRE FEIJÓ, 480 CEP 95190-000
SÃO MARCOS / RS BRASIL
TEL. - FAX (+55) (0) 54 32911416
www.arteferrobrasil.com.br
arteferro@arteferrobrasil.com.br



ARGENTINA

Suarez 760
(1162) Capital Federal Buenos Aires
Republica Argentina
TEL./Fax (+54) 11 43012637
www.laherreria.com



CHILE

LOS ARRAYANES 250,
COMUNA DE COLINA,
SANTIAGO DE CHILE
TEL./FAX (+56) 2 738 7419
www.arteferrochile.cl



SKANDINAVIEN

BRODALSVÄGEN 7 HUS X 433 38
PARTILLE - SWEDEN
TEL. +46 (0) 31 444060 - FAX. +46 (0) 31 444511
www.arteferroinox.se
info@arteferroinox.se

